



CATALOG

00. Revision History ..... 2

01.Characteristics ..... 3

02.Features ..... 3

03.General Specification ..... 3

04.Environmental Characteristics..... 3

05.Optical Characteristics..... 3

06.Electrical Characteristics ..... 4

07.Mechanical Characteristics..... 4

08.Reliability ..... 4

09.Durability ..... 5

10.Inspection Methods..... 5

11.Appearance Inspection..... 6

12.Attention of Mounting Condition..... 6

13.Warranty..... 7

14.Caution..... 7

15.Appearance Specification ..... 8



## 01.Characteristics

**The specification is for Five-Wire analog resistive touch panel.**

1. It is working well even the surface suffered scraped damage if the ITO Glass won't been hurt.
2. 500°C high temperature manufacture process.
3. Warranty is as longer as 2 years for normal operating with 35,000,000 touching times.
4. We provide touch panel with high transparency (more than 80%).It is quite clear even your monitor with low brightness.
5. We could customize various size for customers' request between 5 to 22 inch.
6. It is easy to install into varied brands of monitor.

## 02.Features

Item	Specifications
(1).Type	Five-Wire Analog Resistive Touch Panel
(2).Input Mode	Stylus Pen or Finger
(3).Connector	FFC

## 03.General Specification

(1).Frame Size	
(2).View Area	
(3).Active Area	
(4).Total Thickness	
(5).Tail Length	

## 04.Environmental Characteristics

Item	Temperature	Humidity (Non Condensing)
(1).Operation	-10°C ~ +70°C	20%RH ~85%RH
(2).Storage	-40°C ~ +80°C	10%RH ~ 90%RH

Note: All terms under 1 atmosphere.

## 05.Optical Characteristics

Item	Specifications
(1).Transparency	$\geq 80\% \pm 3\%$ (Measured by BYK-Gardner)
(2).Haze	Antiglare Finish $\leq 10\% \pm 3\%$

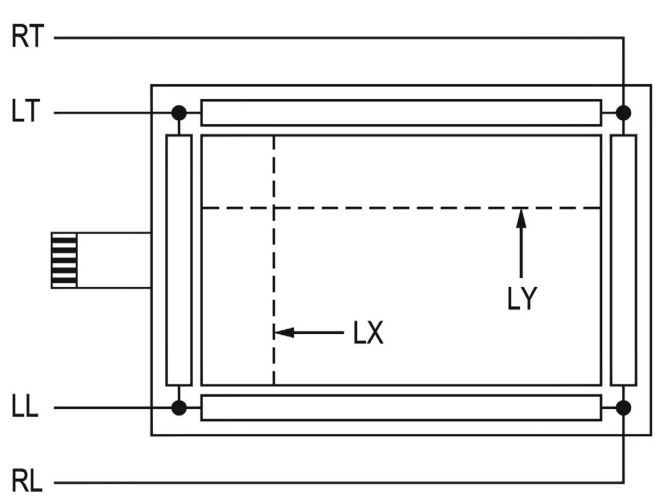
06.Electrical Characteristics		
Item	Specifications	
(1).Loop Resistance	X:20~500Ω, Y:20~500Ω	
(2).Linearity	$X \leq 1.5\%$ , $Y \leq 1.5\%$	
(3).Chattering	$\leq 15\text{ms}$	
(4).Insulation	$\geq 20\text{M}\Omega/25\text{V}(\text{DC})$	
(5).Endurance	No acting damage at DC50V/60sec.	
 <p>Note : Loop Resistance X = short RT and RL , short LT and LL , measure the resistance between RT and LT  Loop Resistance Y = short RT and LT , short RL and LL , measure the resistance between RT and RL</p>		
07.Mechanical Characteristics		
Item	Specification	Condition
(1).Operating Force	Stylus=R0.8	$\leq 50\text{g}$
(2).Impact	13.0 φ DIA. Steel Ball/9g Height=30cm	1 time, no damage [Impact at center area]
(3).Static Load	500g within 10 cm <sup>2</sup> area for 30sec	Satisfy (1) of Item 07 and (1), (2),(4) of Item 06
(4).Hardness	3H pencil, pressure 1N/45°	$\geq 3\text{H}$
(5).Peeling	800g by vertical 90°	Satisfy (1) of Item 06
(6).Bending	135° 10 times left & right	Satisfy (1) of Item 06
08.Reliability		
Item	Specification	Condition
(1).Constant Temperature /Humidity	70°C /90%RH, 500 hrs and normalized for 4 hrs	After the reliability test, the film may have the condition of bubble; nevertheless the electric characteristic still satisfies the following standard. Satisfy (1), (2) of 05; (1), (4) of 06; (2) of 06 satisfies
(2).Heat Cycle	70°C /500 hrs and normalized for 4 hrs	
(3).Cold Cycle	-40°C /500 hrs and normalized for 4 hrs	
		$X \leq 2.5\%$ , $Y \leq 4.0\%$

(4).Thermal Cycle	-40°C ~70°C [60 min./cycle] ×100 cycles and normalized for 4 hrs	
-------------------	------------------------------------------------------------------	--

**09.Durability**

(1).Knock Test	35,000,000 times	Satisfy (1), (2) of Item 5; (1), (4) of Item 6; (2) of item 6 satisfies $X \leq 2.5\%$ , $Y \leq 4.0\%$
----------------	------------------	------------------------------------------------------------------------------------------------------------

**10.Inspection Methods**

**(1). Linearity Condition**  
 Short RT and RL(or short RL and LL) and voltage DC 5V is applied , short LT and LL (or short RT and LT) and ground is applied , using stylus to draw straight points LX and LY at 5.0mm intervals within pattern area and detect the voltage at SG. To measure the voltage differences between RT and LT(or RT and RL) (Fig 10-1) (Fig 10-2)

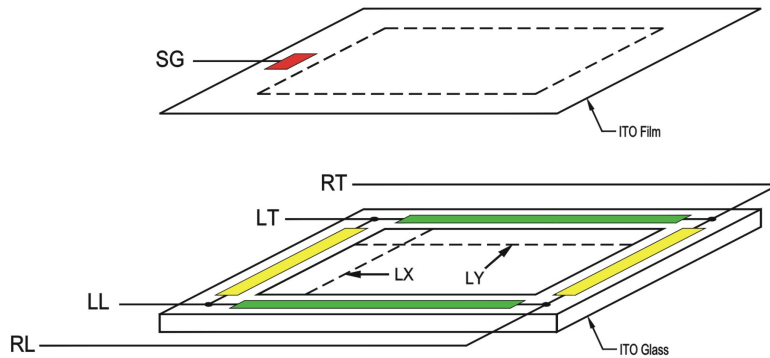

Figure 10-1

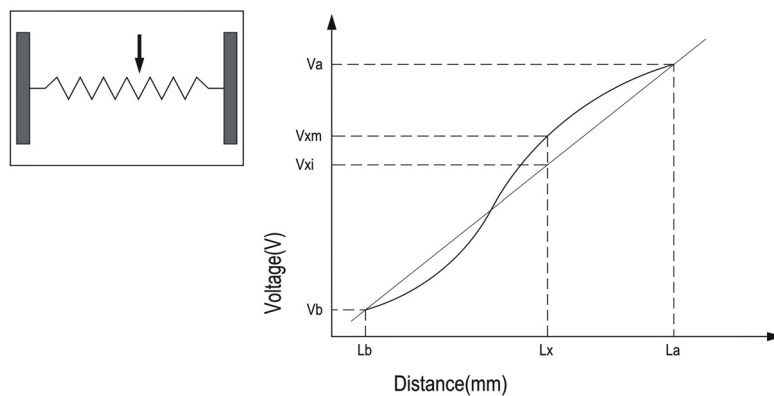

Figure 10-2

※ Linearity:  $[ | V_{xm} - V_{xi} | ] / (V_a - V_b) \times 100\%$

**(2).Specification**

The linearity must be meet the electrical specification outlined in item 6.

**11.Appearance Inspection**

(1)The flaws and impurities are allowed outside viewing area except for those affecting electrical functions.

(2)The inspection was performed with one 17W fluorescent lamp lighting from back or side. The panel was placed 30cm away from eyes. (Figure 11-1)

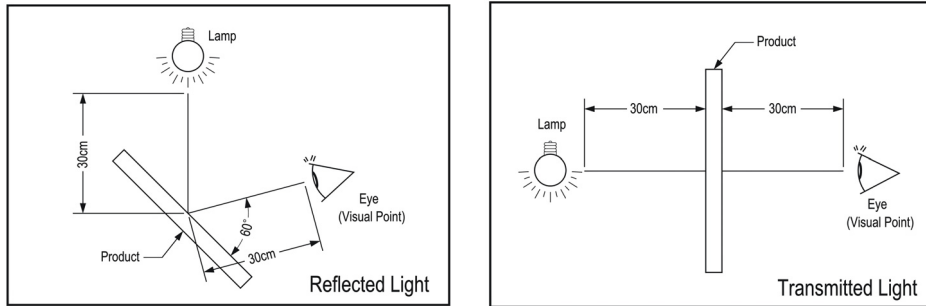

Figure 11-1

(3) Glass Flaw

Item	Picture	Specification
Corner Flaw		$X \leq 3.0\text{mm}$ $Y \leq 3.0\text{mm}$ $Z \leq T$
Edge Flaw		$X \leq 3.0\text{mm}$ $Y \leq 3.0\text{mm}$ $Z \leq T$
Progressive Flaw		Not allowed

Note: T=Glass thickness

**12.Attention of Mounting Condition**

(1) The gasket support of touch panel must be designed on the outside of Viewable area, as well as to avoid pressing on touch panel accidentally, the enclosure must be designed with enough clearance to panel surface. To avoid pressing error on touch panel accidentally, please remain space between the surface of panel and the Bezel.

- (2) Bezel opening must be designed between Viewable area and Active area. Bezel opening must not touch Viewable area.
- (3) We recommend elastic material made support.
- (4) Do not use adhesive to bond top surface (ITO Film) of touch panel with enclosure.
- (5) The edge of touch panel is conductive. Don't touch it with metal after mounting.
- (6) Proper grounding of controller at all times assure normal operation.

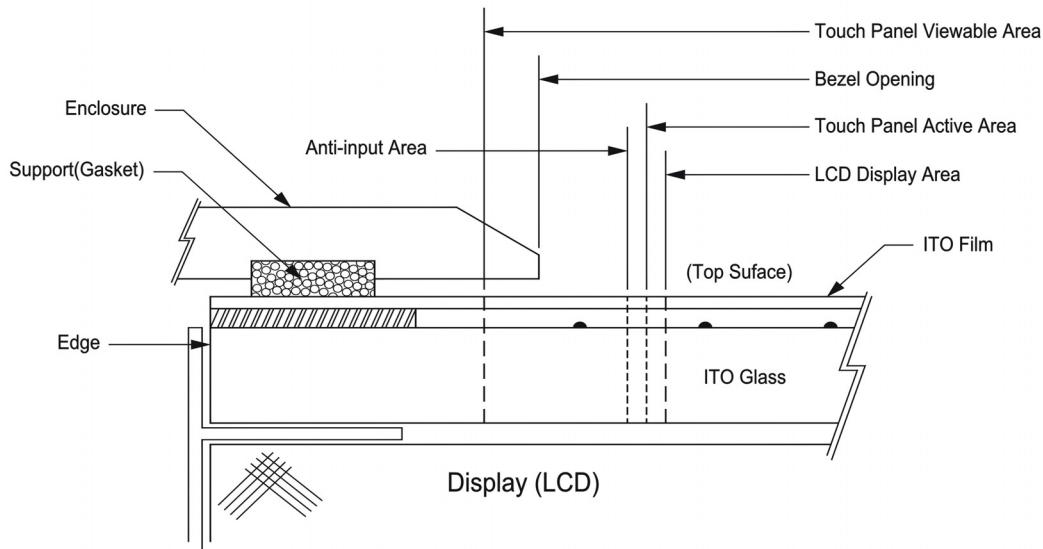

Figure 12-1

### 13. Warranty

GROOVY comes with a 2-year guaranty on 5 wire resistive touch panel. GROOVY guaranty provide for repair and replacement without any charge during this period.

GROOVY reserves the right in its sole discretion to determine the defects received, and will take the responsibility if there is any defect or damages.

Notice: GROOVY is not responsible for following situation:

1. Damages caused by improper handling from clients, such as the shipping period or manufacturing processes.
2. Damages caused by either natural disaster or human factors after receiving the products.
3. Damage caused by self-repairs, and modifications or disassembling of GROOVY products from clients without prior notice.

### 14. Caution

Storage	(1)Storage shall be under the temperature and humidity that mentioned in the specification. Do not expose the products to direct sunlight or piling caused damage on the surface.
Unpacking	(1)Check for the correct vertical direction of the package before unpacking.
Handing	(1) In order to prevent fingerprints or stain on the products, and get a cut by sharp edges of glass, clean finger sacks or glove and mask are required during handing.



	<p>(2) Do not touch the viewing area of the panel.</p> <p>(3) Do not handle the tail (connector) of panel directly, when you handle the touch panel. It will cause the problem of combination and reliability</p>
Cleaning	<p>(1) Clean and soft clothes with neutral detergent and with isopropyl alcohol may be used for cleaning.</p> <p>(2) Do not use any chemical solvent, acidic or alkali solution.</p> <p>(3) The panel is designed with air groove. Insulation and cushioning pads should be designed around the edges of the panel to prevent water and dust.</p>
Install and Assembling	<p>(1) Excessive force or strain to the panel or tail is prohibited.</p> <p>(2) Retain at least 0.3 mm clearance between panel and display module.</p> <p>(3) Gasket or cushion pads around the edge of the panel may segregate water and/or dust contamination.</p>
Operating	<p>(1) Use a plastic stylus (tip R0.8 or over) or finger. Sharp edged or hard articles are prohibited.</p> <p>(2) The gathering of dew in the panel may occur with abrupt temperature or humidity changes. A stable environment condition is recommended.</p>
Others	<p>(1) Keep the surface clean. No adhesives should be applied.</p> <p>(2) Avoid high voltage and static charge.</p> <p>(3) GROOVY has the right to change the materials and specification.</p>

### 15.Appearance Specification

Particle	<p>(1) <math>D \leq 0.25 \rightarrow \text{OK}</math></p> <p>(2) <math>0.25 &lt; D \leq 0.4</math> (each area contains <math>\leq 3</math>, total <math>\leq 5</math>) <math>\rightarrow \text{OK}</math></p> <p>(3) <math>D &gt; 0.4 \rightarrow \text{NG}</math></p>
Linear Object	<p>(1) <math>W \leq 0.05 \rightarrow \text{OK}</math></p> <p>(2) <math>0.05 &lt; W \leq 0.1</math> and <math>L \leq 5.0</math>, total <math>\leq 3 \rightarrow \text{OK}</math></p> <p>(3) <math>W &gt; 0.1 \rightarrow \text{NG}</math></p> <p>Remark: the particle will be ignored when it is cleanable.</p>
Scratch	<p>(1) <math>W \leq 0.025 \rightarrow \text{OK}</math></p> <p>(2) <math>0.025 &lt; W \leq 0.05</math> and <math>L \leq 12.0</math>, total <math>\leq 5 \rightarrow \text{OK}</math></p> <p>(3) <math>0.05 &lt; W \leq 0.1</math> and <math>L \leq 6</math>, total <math>\leq 5 \rightarrow \text{OK}</math></p> <p>(4) <math>W &gt; 0.1 \rightarrow \text{NG}</math></p>

< Remark > All appearance flaws outside AA are acceptable. 【except glass flaws , corner flaws , edge flaws , progressive flaws and scratches mast follow appearance inspection.

1. D=Diameter
2. W=Width
3. L=Length
4. Each area contains=20  $\phi$
5. Unit=mm

Connector Pinout	Pin No.	Designation
1	RT	
2	RL	
3	SG	
4	LT	
5	LL	

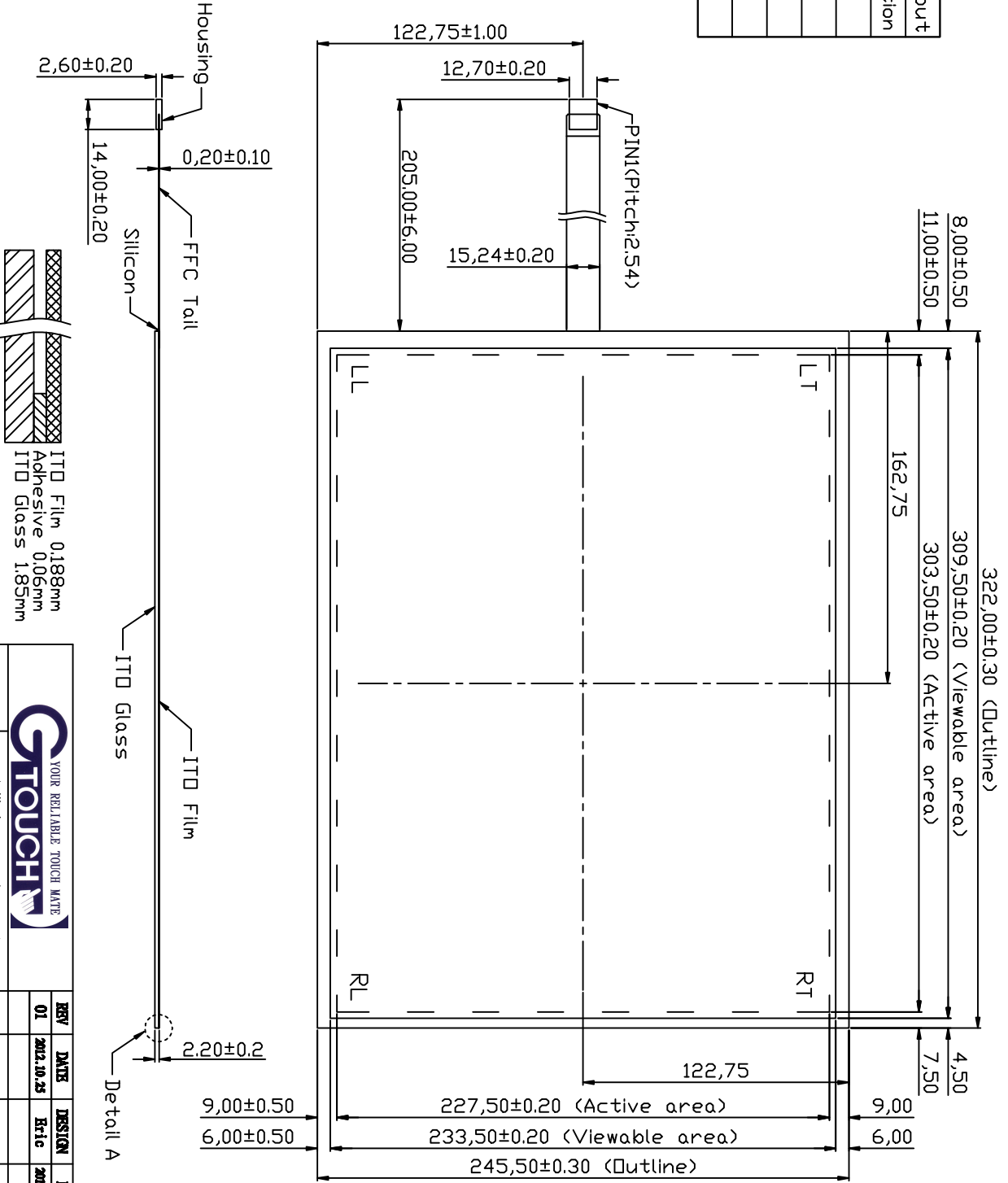

ITD Film 0,188mm  
 Adhesive 0,06mm  
 ITD Glass 1,85mm

Detail A

 YOUR RELIABLE TOUCH MATTE		REV	DATE	DESIGN	DATE	APPROVED
		01	2012.10.25	E+1c	2012.10.25	E+1c
MODEL	15" SW Touch Panel					
DRAWING NO.	GP-150F-5M-NB04B					